



euro3plast

made in italy



LHICUM collection 2015



injection moulded

Tutti gli articoli sono realizzati con resine termoplastiche (PP) resistenti agli urti, al gelo (-20°), ai raggi U.V. e sono interamente riciclabili.

All of the articles are made using polypropylene (PP) resins resistant to shocks, freezing (to -20°), UV rays and are completely recyclable.

Alle Artikel bestehen aus schlagfesten, frostsicheren (-20°) und gegenüber von UV – Strahlen beständigen Thermoplast - Harzen (PP) und sind vollständig recyclingfähig.

Todos los artículos están realizados con resinas termoplásticas (PP), son resistentes a los golpes, al hielo (-20°) y a los rayos UV. Además, todos los productos son íntegramente reciclables.

Tous les articles sont réalisés en résines thermoplastiques (PE) résistant aux chocs, au gel (-20°) et aux rayons U.V. et ils sont entièrement recyclables.



100%
Recyclable



Lightweight



Antishock



U.V.
Resistant



-20°C
Resistant

colors



M9

sabbia
sandy • sand
arena • sable



69

tortora
taupe • taupe
tortola • tourterelle

colors



01

terracotta
terracotta • terracotta
terracota • terre cuite



62

antracite
anthracite grey • anthrazit
antracita • anthracite

colors



L4

rosmarino
rosemary • rosmarin
romero • romarin



N1

giada
jade • jade
jade • jade



44

ciclaminò
cyclamen • cyclamrot
cyclamen • cyclamen



86

verde acido
acid green • apfel grün
verde acido • vert anis



18

ottanio
petrol blue • petrol
azul ottanio • bleu ottanio



02

verde
green • grün
verde • vert

colors



03

bianco
white • weiss
blanco • blanc





miza • cassetta • plant box
 pflanzkasten • jardinera • balconniere

art. 1897 cm. **40** (cm. 40x21,7x18h.) lt. 10
 art. 1898 cm. **50** (cm. 50x21,7x18h.) lt. 13
 art. 1899 cm. **60** (cm. 60x21,7x18h.) lt. 16

miza • sottocassetta • oblong tray
 untersetzer • bandeja • plateau

art. 1900 cm. **40** (cm. 36 x 17,9 x 3 h.)
 art. 1901 cm. **50** (cm. 46 x 17,9 x 3 h.)
 art. 1902 cm. **60** (cm. 56 x 17,9 x 3 h.)



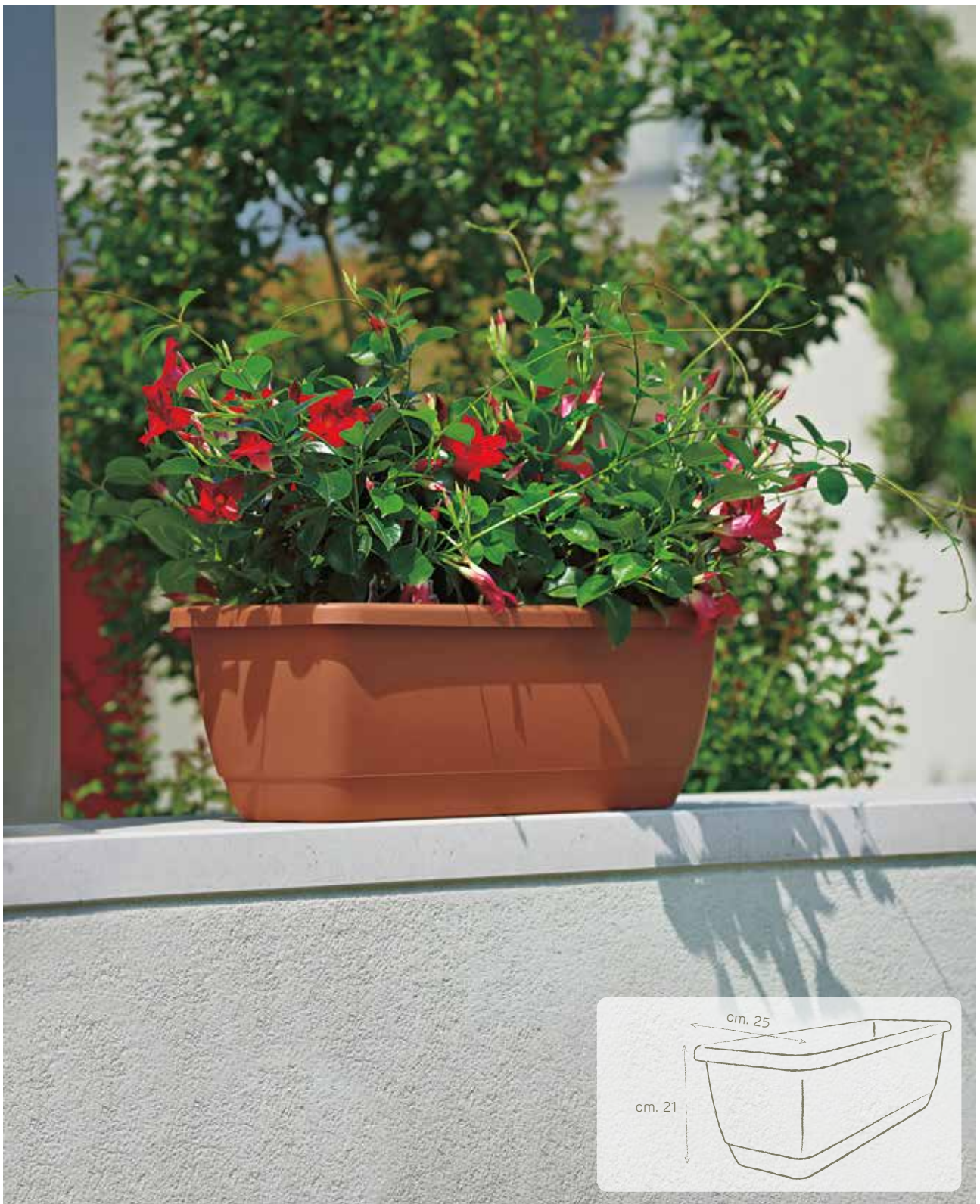

kalis • cassetta • plant box
pflanzkasten • jardinera • jardinière

art. 1941	cm. 50	(cm. 50x25x21h.)	lt. 16
art. 1888	cm. 60	(cm. 60x25x21h.)	lt. 20
art. 1889	cm. 80	(cm. 80x25x21h.)	lt. 28
art. 1890	cm. 100	(cm. 100x25x21h.)	lt. 35

kalis • sottocassetta • oblong tray
untersetzer • bandeja • plateau

art. 1942	cm. 50	(cm. 45,6x20,6x3,5h.)
art. 1891	cm. 60	(cm. 55,6x20,6x3,5h.)
art. 1892	cm. 80	(cm. 75,6x20,6x3,5h.)
art. 1893	cm. 100	(cm. 95,6x20,6x3,5h.)





gerus • cassetta con sottocassetta montata • plant box with attached oblong tray
 pflanzkasten mit montiertem untersetzer • jardinera con bandeja montada • balconniere avec plateau clipsé

art. 1993	cm. 40	(cm. 40x19,5x16,7h.)	lt. 8
art. 1994	cm. 50	(cm. 50x19,5x16,7h.)	lt. 10
art. 1995	cm. 60	(cm. 60x19,5x16,7h.)	lt. 12
art. 2054	cm. 80	(cm. 80x19,5x16,7h.)	lt. 17





inis • cassetta • plant box
 pflanzkasten • jardinera • balconniere

art. 1987 cm. **40** (cm. 40x19,5x16,4h.) lt. 8
 art. 1988 cm. **50** (cm. 50x19,5x16,4h.) lt. 10
 art. 1989 cm. **60** (cm. 60x19,5x16,4h.) lt. 12
 art. 2055 cm. **80** (cm. 80x19,5x16,4h.) lt. 17

inis • sottocassetta • oblong tray
 untersetzer • bandeja • plateau

art. 1990 cm. **40** (cm. 36,6 x 16,1 x 3 h.)
 art. 1991 cm. **50** (cm. 46,6 x 16,1 x 3 h.)
 art. 1992 cm. **60** (cm. 56,6 x 16,1 x 3 h.)
 art. 2056 cm. **80** (cm. 76,6 x 16,1 x 3 h.)









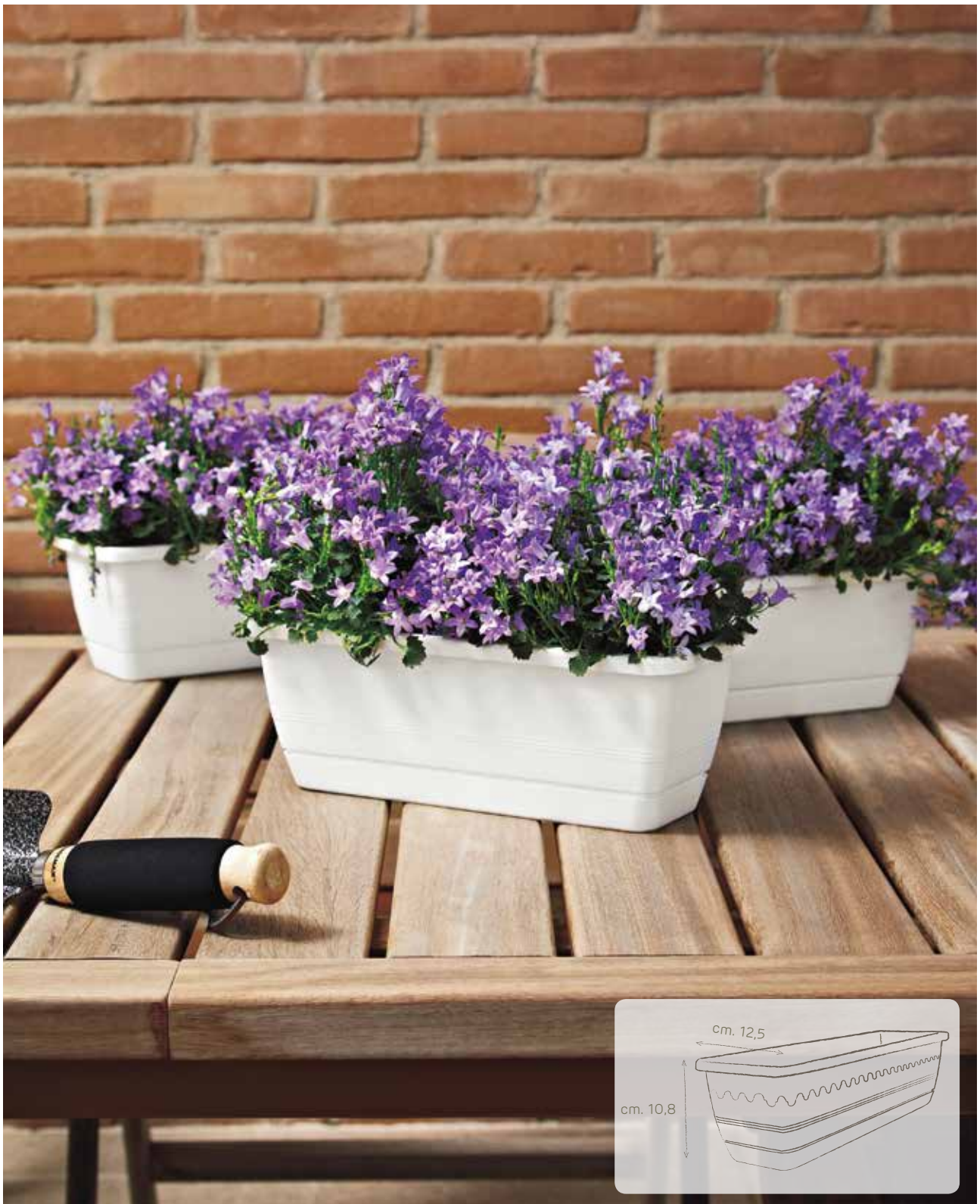

licum • cassetta con sottocassetta montata • plant box with attached oblong tray
 pflanzkasten mit montiertem untersetzer • jardinera con bandeja montada • balconniere avec plateau clipsé

art. 1999 cm. 20 (cm. 20x12,5x10,8h.) lt. 1,5

art. 2000 cm. 30 (cm. 30x12,5x10,8h.) lt. 2,5

art. 2001 cm. 40 (cm. 40x12,5x10,8h.) lt. 3







dune • cassetta con sottocassetta montata • plant box with attached oblong tray
 pflanzkasten mit montiertem untersetzer • jardinière con bandeja montada • jardinière avec plateau clipsé

art. 2338 cm. **40** (cm. 40 x 20 x 18 h.) lt. 8

art. 2339 cm. **50** (cm. 50 x 20 x 18 h.) lt. 10

art. 2340 cm. **60** (cm. 60 x 20 x 18 h.) lt. 12

art. 2341 cm. **80** (cm. 80 x 20 x 18 h.) lt. 17

art. 2342 cm. **100** (cm. 100 x 20 x 18 h.) lt. 21





rigata • cassetta • plant box
pflanzkasten • jardinera • jardinière

art. 1224 cm. **50** (cm. 49 x 25 x 21 h.) lt. 18
 art. 1199 cm. **60** (cm. 62 x 31 x 25 h.) lt. 33
 art. 1202 cm. **80** (cm. 82 x 41 x 33 h.) lt. 79
 art. 1205 cm. **100** (cm. 98 x 46 x 42 h.) lt. 128

maxi • sottocassetta • oblong tray
untersetzer • bandeja • plateau

art. 1228 cm. **50** (cm. 49 x 25 x 4 h.)
 art. 1186 cm. **60** (cm. 63 x 30 x 4 h.)
 art. 1168 cm. **80** (cm. 82 x 39 x 4 h.)
 art. 1191 cm. **90** (cm. 90 x 40 x 5 h.)





akea • cassetta • plant box
pflanzkasten • jardinera • jardinière

art. 1680 cm. **50** (cm. 50 x 28 x 22 h.) lt. 16

art. 1681 cm. **60** (cm. 60 x 31 x 26 h.) lt. 26

art. 1683 cm. **80** (cm. 80 x 39 x 34 h.) lt. 60 *●●

art. 1684 cm. **100** (cm. 100 x 46 x 40 h.) lt. 100 *●●

akea • sottocassetta • oblong tray
untersetzer • bandeja • plateau

art. 1685 cm. **50** (cm. 46 x 22 x 3 h.)

art. 1686 cm. **60** (cm. 55 x 26 x 3,7 h.)

art. 1687 cm. **80** (cm. 73 x 32 x 4,7 h.) *●●

art. 1689 cm. **100** (cm. 90 x 36 x 5,7 h.) *●●



* colore disponibile • * color available
* diese farbe • * color disponible • * coloris disponibles





krea • vaso quadro • square pot
 pflanzkübel quadratisch • maceta cuadrada • pot carré

art. 1702	cm. 25	(cm. 25 x 25 x 22 h.)	lt. 6,5
art. 1703	cm. 30	(cm. 31 x 31 x 26 h.)	lt. 12
art. 1704	cm. 35	(cm. 35 x 35 x 30 h.)	lt. 17
art. 1705	cm. 40	(cm. 39 x 39 x 34 h.)	lt. 24 *●●●
art. 1706	cm. 45	(cm. 46 x 46 x 40 h.)	lt. 38 *●●●

krea • sottovaso quadro • square saucer
 untersetzer quadratisch • plato cuadrado • soucoupe carrée

art. 1707	cm. 25	(cm. 22 x 22 x 3 h.)
art. 1708	cm. 30	(cm. 26 x 26 x 3,7 h.)
art. 1709	cm. 35	(cm. 29 x 29 x 4,2 h.)
art. 1710	cm. 40	(cm. 32 x 32 x 4,7 h.) *●●●
art. 1711	cm. 45	(cm. 36 x 36 x 5,7 h.) *●●●



* colore disponibile • * color available
 * diese farbe • * color disponible • * coloris disponibles









krea • vaso a muro • wall pot
wandkübel • maceta de pared • pot mural

art. 1742 cm. 45 (cm. 46 x 38 x 40 h.) lt.27

krea • sottovaso a muro • wall saucer
wanduntersetzer • plato de pared • soucoupe mural

art. 1744 cm. 45 (cm.36x30x5,7h.)





krea • vaso angolo • angle pot
eckkübel • maceta de esquina • pot angle

art. 1743 cm. 45 (cm. 46x46x40 h.) lt. 35

krea • sottovaso angolo • angle saucer
eckuntersetzer • plato de esquina • soucoupe angle

art. 1745 cm. 45 (cm. 39x39x5,7 h.)





dune • vaso • pot
pflanzkübel • maceta • pot

art. 1279 Ø 18 (cm. 18 x 14 h.) lt. 1,6
 art. 1280 Ø 20 (cm. 20 x 16 h.) lt. 2,5
 art. 1281 Ø 25 (cm. 25 x 19 h.) lt. 5
 art. 1282 Ø 30 (cm. 29 x 23 h.) lt. 8
 art. 1283 Ø 35 (cm. 34 x 27 h.) lt. 13

art. 1284 Ø 40 (cm. 39 x 31 h.) lt. 19
 art. 1285 Ø 45 (cm. 44 x 35 h.) lt. 29
 art. 1286 Ø 50 (cm. 49 x 39 h.) lt. 39
 art. 1287 Ø 60 (cm. 59 x 47 h.) lt. 67
 art. 1288 Ø 70 (cm. 68 x 54 h.) lt. 105



coccio • vaso • pot
pflanzkübel • maceta • pot

art. 1062 ø **16** (cm. 16 x 14 h.) lt. 1
 art. 1063 ø **18** (cm. 18 x 16 h.) lt. 2
 art. 1064 ø **20** (cm. 20 x 17 h.) lt. 3
 art. 1065 ø **22** (cm. 22 x 19 h.) lt. 4
 art. 1246 ø **24** (cm. 24 x 21 h.) lt. 6
 art. 1247 ø **27** (cm. 27 x 23 h.) lt. 8
 art. 1248 ø **30** (cm. 30 x 25 h.) lt. 11

art. 1249 ø **35** (cm. 35 x 27 h.) lt. 18
 art. 1316 ø **40** (cm. 40 x 31 h.) lt. 25
 art. 1317 ø **45** (cm. 45 x 35 h.) lt. 34
 art. 1318 ø **50** (cm. 50 x 38 h.) lt. 48
 art. 1394 ø **60** (cm. 60 x 46 h.) lt. 83
 art. 1427 ø **70** (cm. 70 x 53 h.) lt. 132



linto • vaso • pot
pflanzkübel • maceta • pot

art. 1662	Ø 14	(cm. 14 x 11 h.)	lt. 0,9		
art. 1663	Ø 16	(cm. 16 x 13 h.)	lt. 1,2		
art. 1664	Ø 18	(cm. 18 x 14 h.)	lt. 1,6		
art. 1665	Ø 20	(cm. 20 x 16 h.)	lt. 2,5	*●●	
art. 1666	Ø 25	(cm. 25 x 20 h.)	lt. 4,8	*●●	
art. 1667	Ø 30	(cm. 30 x 23 h.)	lt. 8,3	*●●	
art. 1668	Ø 35	(cm. 35 x 27 h.)	lt. 13,5	*●●	
art. 1669	Ø 40	(cm. 40 x 31 h.)	lt. 19		*●●
art. 1670	Ø 45	(cm. 45 x 35 h.)	lt. 29		
art. 1671	Ø 50	(cm. 50 x 39 h.)	lt. 39		
art. 1672	Ø 60	(cm. 60 x 46 h.)	lt. 67		
art. 2028	Ø 70	(cm. 70 x 51 h.)	lt. 100		
art. 2029	Ø 85	(cm. 85 x 57 h.)	lt. 171		



* colore disponibile • * color available
* diese farbe • * color disponible • * coloris disponibles

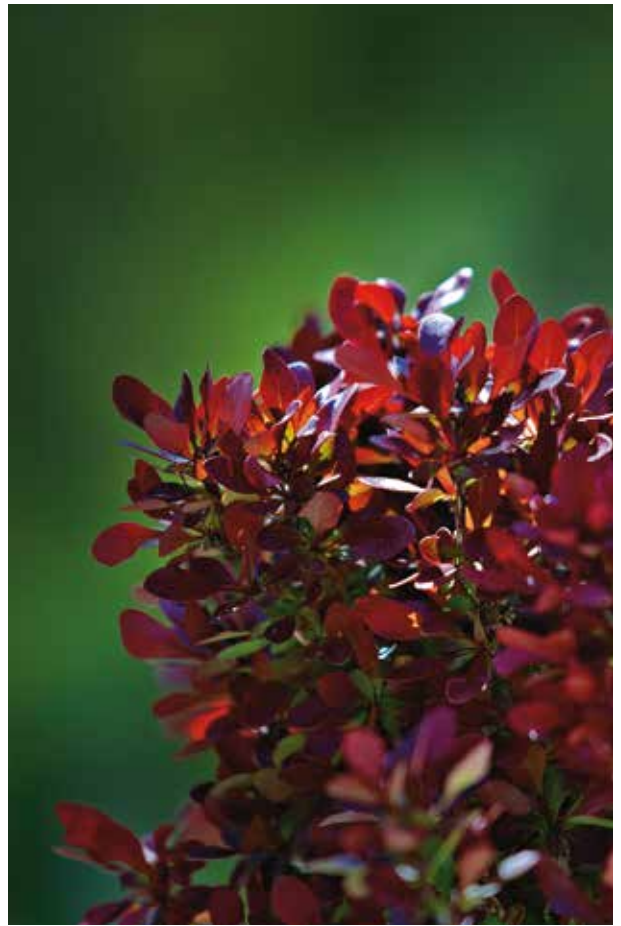



geo • vaso • pot
pflanzkübel • maceta • pot

art. 1983	Ø 13	(cm. 13 x 10 h.)	lt. 0,8	* ● ● ●	art. 1978	Ø 40	(cm. 40 x 30 h.)	lt. 23,2	* ● ● ● ● ● ● ● ●
art. 1972	Ø 15	(cm. 15 x 11 h.)	lt. 1,2	* ● ● ●	art. 1979	Ø 45	(cm. 45 x 34 h.)	lt. 33	* ● ● ● ● ● ● ● ●
art. 1973	Ø 18	(cm. 18 x 14 h.)	lt. 2	* ● ● ●	art. 1980	Ø 50	(cm. 50 x 38 h.)	lt. 45,3	* ● ● ● ● ● ● ● ●
art. 1974	Ø 20	(cm. 20 x 15 h.)	lt. 2,9	* ● ● ● ● ● ● ● ●	art. 2058	Ø 55	(cm. 55 x 41 h.)	lt. 60,4	
art. 1975	Ø 25	(cm. 25 x 19 h.)	lt. 5,6	* ● ● ● ● ● ● ● ●	art. 1981	Ø 60	(cm. 60 x 45 h.)	lt. 78,4	
art. 1976	Ø 30	(cm. 30 x 23 h.)	lt. 9,7	* ● ● ● ● ● ● ● ●	art. 1982	Ø 70	(cm. 70 x 53 h.)	lt. 124,6	
art. 1977	Ø 35	(cm. 35 x 26 h.)	lt. 15,4	* ● ● ● ● ● ● ● ●					



* colore disponibile • * color available
* diese farbe • * color disponible • * coloris disponibles









cilindro • vaso • pot
 pflanzkübel • maceta • pot

art. 1192	Ø 10	(cm. 10 x 7 h.)	lt. 0,3	art. 1112	Ø 35	(cm. 35 x 25 h.)	lt. 14
art. 1244	Ø 13	(cm. 13 x 9 h.)	lt. 0,7	art. 1113	Ø 40	(cm. 40 x 28 h.)	lt. 21
art. 1193	Ø 15	(cm. 15 x 11 h.)	lt. 1	art. 1114	Ø 45	(cm. 45 x 31 h.)	lt. 25
art. 1245	Ø 18	(cm. 18 x 13 h.)	lt. 1,8	art. 1125	Ø 50	(cm. 50 x 35 h.)	lt. 41
art. 1175	Ø 20	(cm. 20 x 14 h.)	lt. 2,5	art. 1176	Ø 60	(cm. 60 x 42 h.)	lt. 70
art. 1174	Ø 25	(cm. 25 x 18 h.)	lt. 5	art. 1194	Ø 70	(cm. 70 x 49 h.)	lt. 115
art. 1124	Ø 30	(cm. 30 x 21 h.)	lt. 9	art. 1300	Ø 90	(cm. 90 x 62 h.)	lt. 250 *●●

69* 62* 01

* colore disponibile • * color available
 * diese farbe • * color disponible • * coloris disponibles



piedino • piedino • little base
fuss • pie • support

art. 1462 (cm. 7,7 x 4,1 x 4,9 h.)



konis • vaso con sottovaso • pot with saucer
pflanzkübel mit untersetzer • maceta con plato • pot avec soucoupe

art. 2117 ø 24 (cm. 24 x 30 h.) lt. 8,4

art. 2218 ø 28 (cm. 28 x 35 h.) lt. 11,5



eolia • ciotola con sottovaso montato • plant bowl with attached saucer
 pflanzschale mit montiertem untersetzer • terrina con plato montados • coupe avec soucoupe clipsée

art. 1906 ø **17** (cm. 17 x 10 h.) lt. 1,3
 art. 1907 ø **19** (cm. 19 x 11 h.) lt. 1,8
 art. 1908 ø **23** (cm. 23 x 13 h.) lt. 3,2
 art. 1909 ø **28** (cm. 28 x 14 h.) lt. 5,3
 art. 1910 ø **32** (cm. 32 x 16 h.) lt. 7,7

art. 1911 ø **38** (cm. 38 x 18 h.) lt. 12,3
 art. 1957 ø **43** (cm. 43 x 20 h.) lt. 17,8
 art. 2059 ø **48** (cm. 48 x 23 h.) lt. 24,5
 art. 2060 ø **54** (cm. 54 x 26 h.) lt. 34,6



olimpo • ciotola • plant bowl
pflanzschale • terrina • coupe

art. 1375 ø 20 (cm. 20 x 8 h.) lt. 1,4



art. 1376 ø 25 (cm. 25 x 9 h.) lt. 2,7



art. 1359 ø 30 (cm. 30 x 11 h.) lt. 4,7



art. 1454 ø 35 (cm. 35 x 13 h.) lt. 7,5

art. 1360 ø 40 (cm. 40 x 15 h.) lt. 11

art. 1500 ø 45 (cm. 45 x 17 h.) lt. 16

art. 1361 ø 50 (cm. 50 x 19 h.) lt. 22

art. 1362 ø 60 (cm. 60 x 23 h.) lt. 38

art. 1363 ø 70 (cm. 70 x 27 h.) lt. 60

art. 1455 ø 90 (cm. 90 x 34 h.) lt. 128



* colore disponibile • * color available

* diese farbe • * color disponibile • * coloris disponibles





eolia • ciotola appesa con sottovaso montato • hanging plant bowl with attached saucer
hängeampel mit montiertem untersetzer • terrina de colgar con plato montados • coupe suspendue avec soucoupe clipsée

art. 1912 ø **19** (cm. 19 x 13 h.) lt. 1,8

art. 1913 ø **23** (cm. 23 x 15 h.) lt. 3,2

art. 1914 ø **28** (cm. 28 x 17 h.) lt. 5,3

art. 1915 ø **32** (cm. 32 x 19 h.) lt. 7,7

art. 1949 ø **38** (cm. 38 x 22 h.) lt. 12,3



azem • ciotola appesa con sottovaso montato • hanging plant bowl with attached saucer
hängeampel mit montiertem untersetzer • terrina de colgar con plato montados • coupe suspendue avec soucoupe clipsée

art. 2021 ø **25** (cm. 25 x 18 h.) lt. 3,2

art. 2022 ø **30** (cm. 30 x 21 h.) lt. 5,7

art. 2023 ø **35** (cm. 35 x 25 h.) lt. 9



olimpo • gerla con sottovaso • wall pot with saucer
wandkübel mit untersetzer • maceta de pared con plato • pot mural avec soucoupe

art. 1802 cm. **25** (cm. 25 x 16 x 18 h.) lt. 2,9

art. 1803 cm. **30** (cm. 30 x 19 x 21 h.) lt. 5,1



domus • gerla con sottovaso • wall pot with saucer
wandkübel mit untersetzer • maceta de pared con plato • pot mural avec soucoupe

art. 1800 cm. **25** (cm. 25 x 16 x 18 h.) lt. 2,9

art. 1801 cm. **30** (cm. 30 x 19 x 21 h.) lt. 5,1



azem • fioriera • vase
blumenspindel • copa • coupe sur pied

art. 2010 ø 30 (cm. 30 x 28 h.) lt. 5,7

art. 2011 ø 35 (cm. 35 x 33 h.) lt. 9

art. 2012 ø 40 (cm. 40 x 38 h.) lt. 13,5

art. 2013 ø 45 (cm. 45 x 42 h.) lt. 20,5





medea • sottovaso • saucer
untersetzer • plato • soucoupe

art. 1469	Ø 8	(cm. 9,6 x 1,6 h.)		art. 1480	Ø 30	(cm. 30 x 4,4 h.)	*●
art. 1470	Ø 10	(cm. 11 x 1,8 h.)	*●	art. 1481	Ø 32	(cm. 32 x 4,6 h.)	*○●●●●●●●●
art. 1471	Ø 12	(cm. 12,8 x 2,1 h.)	*○●●●●●●	art. 1482	Ø 36	(cm. 36 x 5 h.)	*○●●●●
art. 1472	Ø 14	(cm. 14,3 x 2,4 h.)	*○●●●●●●	art. 1483	Ø 40	(cm. 40 x 5,4 h.)	*○●●●●●●●●
art. 1473	Ø 16	(cm. 15,9 x 2,6 h.)	*○●●●●●	art. 1484	Ø 44	(cm. 44 x 5,8 h.)	*○●●●●●●●●
art. 1474	Ø 18	(cm. 17,9 x 2,9 h.)	*○●●●●●●●●	art. 1485	Ø 48	(cm. 48 x 6,2 h.)	*○●●●●●●●●
art. 1475	Ø 20	(cm. 20 x 3,3 h.)	*○●●●●●●●●	art. 1486	Ø 52	(cm. 52 x 6,7 h.)	*○●●●●
art. 1476	Ø 22	(cm. 22 x 3,6 h.)	*○●●●●●●●●	art. 1487	Ø 56	(cm. 56 x 6,9 h.)	*○●●●●
art. 1477	Ø 24	(cm. 23,9 x 3,7 h.)	*○●●●●●●●●	art. 1488	Ø 64	(cm. 64 x 7 h.)	*○●●●●
art. 1478	Ø 26	(cm. 26 x 3,9 h.)	*○●●●●●●●●	art. 1960	Ø 82	(cm. 82 x 8,7 h.)	
art. 1479	Ø 28	(cm. 27,9 x 4,2 h.)	*○●●●●●●●●				

03* M9* G9* 62* N1* 86* L4* I8* 44* 01
 * colore disponibile • * color available
 * diese farbe • * color disponible • * coloris disponibles





dekus air • sottovaso quadro trasparente • transparent square saucer
 quadratischer untersetzer transparent • plato cuadrado transparente • soucoupe transparente carrée

art. 2613 cm. **14** (cm. 14 x 14 x 2,3 h.)

art. 2614 cm. **19** (cm. 19 x 19 x 3,1 h.)

art. 2615 cm. **23** (cm. 23 x 23 x 3,8 h.)

art. 2616 cm. **27** (cm. 27 x 27 x 4,5 h.)

art. 2617 cm. **32** (cm. 32 x 32 x 5,2 h.)

art. 2618 cm. **39** (cm. 39 x 39 x 6,3 h.)



air • sottovaso trasparente • transparent saucer
 untersetzer transparent • plato transparente • soucoupe transparente

art. 2619	Ø 10	(cm. 10 x 2,3 h.)	art. 2627	Ø 26	(cm. 25,9 x 4,2 h.)
art. 2620	Ø 12	(cm. 11,9 x 2,5 h.)	art. 2628	Ø 28	(cm. 27,9 x 4,5 h.)
art. 2621	Ø 14	(cm. 13,9 x 2,9 h.)	art. 2629	Ø 30	(cm. 29,8 x 4,7 h.)
art. 2622	Ø 16	(cm. 15,7 x 3,1 h.)	art. 2630	Ø 35	(cm. 34,9 x 5 h.)
art. 2623	Ø 18	(cm. 17,9 x 3,3 h.)	art. 2631	Ø 40	(cm. 39,9 x 5,2 h.)
art. 2624	Ø 20	(cm. 19,8 x 3,5 h.)	art. 2632	Ø 45	(cm. 45 x 5,5 h.)
art. 2625	Ø 22	(cm. 21,9 x 3,6 h.)	art. 2633	Ø 50	(cm. 49,8 x 5,6 h.)
art. 2626	Ø 24	(cm. 23,9 x 3,9 h.)			



sottovaso con ruote • sottovaso con ruote • saucer with attached rollers • untersetzer mit montierten rollen
plato con ruedas montadas • soucoupe avec roues cilpsées

art. 1954 Ø 21 (cm. 21,1 x 9,2 h.)

art. 1107 Ø 25 (cm. 24,8x10,8h.)

art. 1108 Ø 28 (cm. 27,8 x 11 h.)

art. 1109 Ø 31 (cm. 30,3 x 11,1 h.)

art. 1110 Ø 35 (cm. 35,4 x 11,4 h.)

art. 1955 Ø 39 (cm. 39 x 12 h.)

art. 1111 Ø 42 (cm. 42 x 12 h.)

art. 1661 Ø 48 (cm. 48,4x12,2h.)

art. 1956 Ø 56 (cm. 56 x 13,1 h.)





gerani • cassetta • plant box
pflanzkasten • jardinera • balconniere

art. 1017	cm. 30	(cm. 30 x 17 x 14 h.)	lt. 5
art. 1018	cm. 35	(cm. 35 x 17 x 14 h.)	lt. 6
art. 1019	cm. 40	(cm. 40 x 17 x 14 h.)	lt. 7
art. 1020	cm. 50	(cm. 50 x 17 x 14 h.)	lt. 9
art. 1021	cm. 60	(cm. 60 x 17 x 14 h.)	lt. 11



gerani • sottocassetta • oblong tray
untersetzer • bandeja • plateau

art. 1067	cm. 30	(cm. 26 x 13 x 3 h.)
art. 1068	cm. 35	(cm. 31 x 13 x 3 h.)
art. 1069	cm. 40	(cm. 36 x 13 x 3 h.)
art. 1070	cm. 50	(cm. 46 x 13 x 3 h.)
art. 1071	cm. 60	(cm. 56 x 13 x 3 h.)



garden • sottocassetta • oblong tray
untersetzer • bandeja • plateau

art. 360	cm. 30	(cm. 29 x 16 x 2 h.)
art. 361	cm. 35	(cm. 34 x 16 x 2 h.)
art. 362	cm. 40	(cm. 39 x 16 x 2 h.)
art. 363	cm. 50	(cm. 49 x 16 x 2 h.)
art. 364	cm. 60	(cm. 59 x 16 x 2 h.)





maxi • sottocassetta • oblong tray
untersetzer • bandeja • plateau

art. 1228 cm. **50** (cm. 49x25x4 h.)

art. 1186 cm. **60** (cm. 63x30x4 h.)

art. 1167 cm. **70** (cm. 74x35x4 h.)

art. 1168 cm. **80** (cm. 82x39x4 h.)

art. 1191 cm. **90** (cm. 90x40x5 h.)

art. 1169 cm. **100** (cm. 101x47x5 h.)

01



quadro • sottovaso • saucer
untersetzer • plato • soucoupe

art. 1170 cm. **29** (cm. 28 x 28 x 4 h.)

art. 1171 cm. **34** (cm. 33 x 33 x 4 h.)

art. 1172 cm. **39** (cm. 38 x 38 x 5 h.)

art. 1173 cm. **47** (cm. 47 x 47 x 5 h.)

01

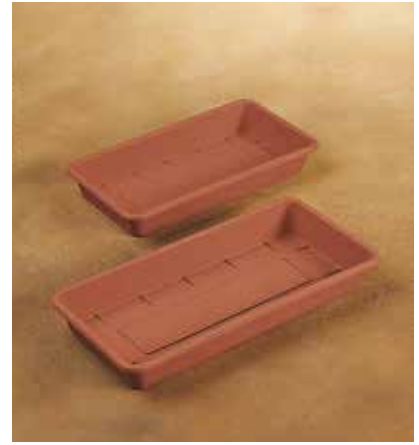

mini • sottocassetta • oblong tray
untersetzer • bandeja • plateau

art. 1238 cm. **30** (cm. 30 x 16 x 4 h.)

art. 1239 cm. **35** (cm. 35 x 17 x 5 h.)

art. 1240 cm. **40** (cm. 41 x 18 x 5 h.)

art. 1241 cm. **46** (cm. 47 x 20 x 5 h.)

art. 1242 cm. **52** (cm. 53 x 22 x 6 h.)

art. 1243 cm. **62** (cm. 63 x 23 x 7 h.)

01



sabbiato • sottovaso • saucer
untersetzer • plato • soucoupe

art. 1313 ø **6** (cm. 6 x 1,3 h.)

art. 1314 ø **8** (cm. 8 x 1,5 h.)

art. 1229 ø **10** (cm. 9 x 1,4 h.)

art. 3/12 ø **12** (cm. 12 x 2,4 h.)

art. 3/14 ø **14** (cm. 14 x 2,7 h.)

art. 3/16 ø **16** (cm. 16,2x2,9 h.)

art. 3/18 ø **18** (cm. 18 x 3,2 h.)

art. 3/20 ø **20** (cm. 20 x 3,4 h.)

art. 3/22 ø **22** (cm. 22 x 3,7 h.)

art. 3/24 ø **24** (cm. 24 x 4 h.)

art. 3/26 ø **26** (cm. 26 x 4,2 h.)

art. 3/28 ø **28** (cm. 28 x 4,4 h.)

art. 3/30 ø **30** (cm. 30 x 4,7 h.)

art. 3/35 ø **35** (cm. 35 x 5 h.)

art. 3/40 ø **40** (cm. 40 x 5,3 h.)

art. 3/45 ø **45** (cm. 45 x 5,5 h.)

art. 3/50 ø **50** (cm. 50 x 5,2 h.)

art. 3/55 ø **55** (cm. 58,6 x 5,8 h.)

art. 3/60 ø **60** (cm. 63,6 x 6 h.)

01



garden • vaso • pot
 pflanzkübel • maceta • pot

art. 349 Ø 12 (cm. 12 x 10 h.) lt. 0,6
 art. 350 Ø 14 (cm. 14 x 12 h.) lt. 0,9
 art. 351 Ø 16 (cm. 16 x 14 h.) lt. 1,5
 art. 352 Ø 18 (cm. 18 x 16 h.) lt. 2,3
 art. 353 Ø 20 (cm. 20 x 18 h.) lt. 3,3

art. 354 Ø 22 (cm. 22 x 19 h.) lt. 4,4
 art. 355 Ø 24 (cm. 24 x 21 h.) lt. 5,5
 art. 356 Ø 27 (cm. 27 x 22 h.) lt. 8
 art. 357 Ø 30 (cm. 30 x 23 h.) lt. 11
 art. 918 Ø 35 (cm. 35 x 26 h.) lt. 17





moplen • sottovaso • saucer
 untersetzer • plato • soucoupe

art. 1037	Ø 10	(cm. 10 x 2,3 h.)
art. 1/12	Ø 12	(cm. 11,9 x 2,5 h.)
art. 1/14	Ø 14	(cm. 13,9 x 2,9 h.)
art. 1/16	Ø 16	(cm. 15,7 x 3,1 h.)
art. 1/18	Ø 18	(cm. 17,9 x 3,3 h.)
art. 1/20	Ø 20	(cm. 19,8 x 3,5 h.)
art. 1/22	Ø 22	(cm. 21,9 x 3,6 h.)
art. 1/24	Ø 24	(cm. 23,9 x 3,9 h.)
art. 1/26	Ø 26	(cm. 25,9 x 4,2 h.)
art. 1/28	Ø 28	(cm. 27,9 x 4,5 h.)
art. 1/30	Ø 30	(cm. 29,8 x 4,7 h.)
art. 1/35	Ø 35	(cm. 34,9 x 5 h.)
art. 1/40	Ø 40	(cm. 39,9 x 5,2 h.)
art. 1/45	Ø 45	(cm. 45 x 5,5 h.)
art. 1/50	Ø 50	(cm. 49,8 x 5,6 h.)

03 02



moplen • sottocassetta • oblong tray
 untersetzer • bandeja • plateau

art. 2/25	cm. 25	(cm. 25x15x4 h.)
art. 2/30	cm. 30	(cm. 30x16x4 h.)
art. 2/35	cm. 35	(cm. 35x17x5 h.)
art. 2/40	cm. 40	(cm. 40x18x5 h.)
art. 2/46	cm. 46	(cm. 46x20x5 h.)
art. 2/52	cm. 52	(cm. 52x22x5,9 h.)
art. 2/62	cm. 62	(cm. 63x20x5,8 h.)

02



cassetta con riserva d'acqua
plant box with water reserve
pflanzkasten mit langzeitbewässerung
jardinera con reserva de agua
jardinière avec réserve d'eau

kalis

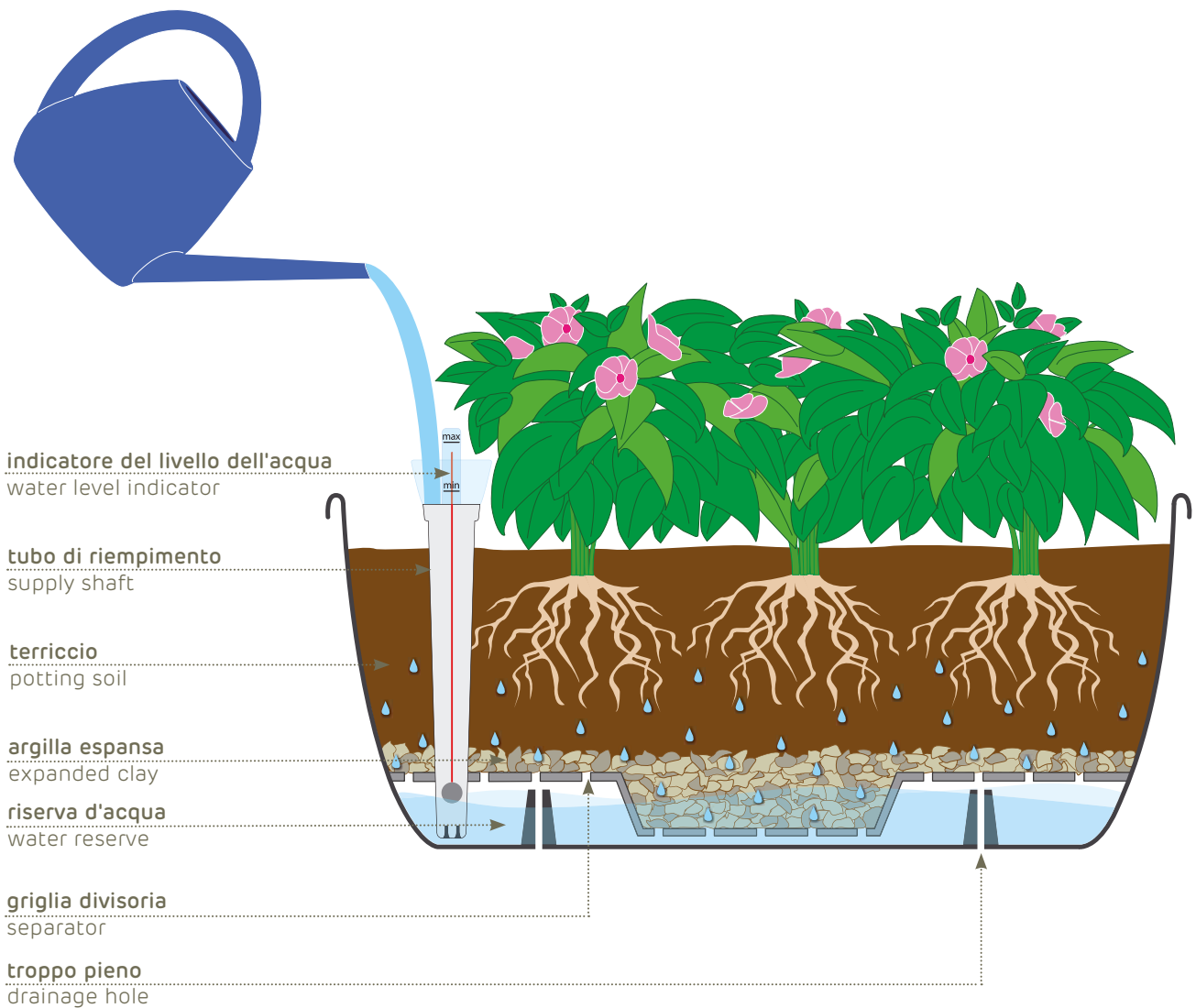

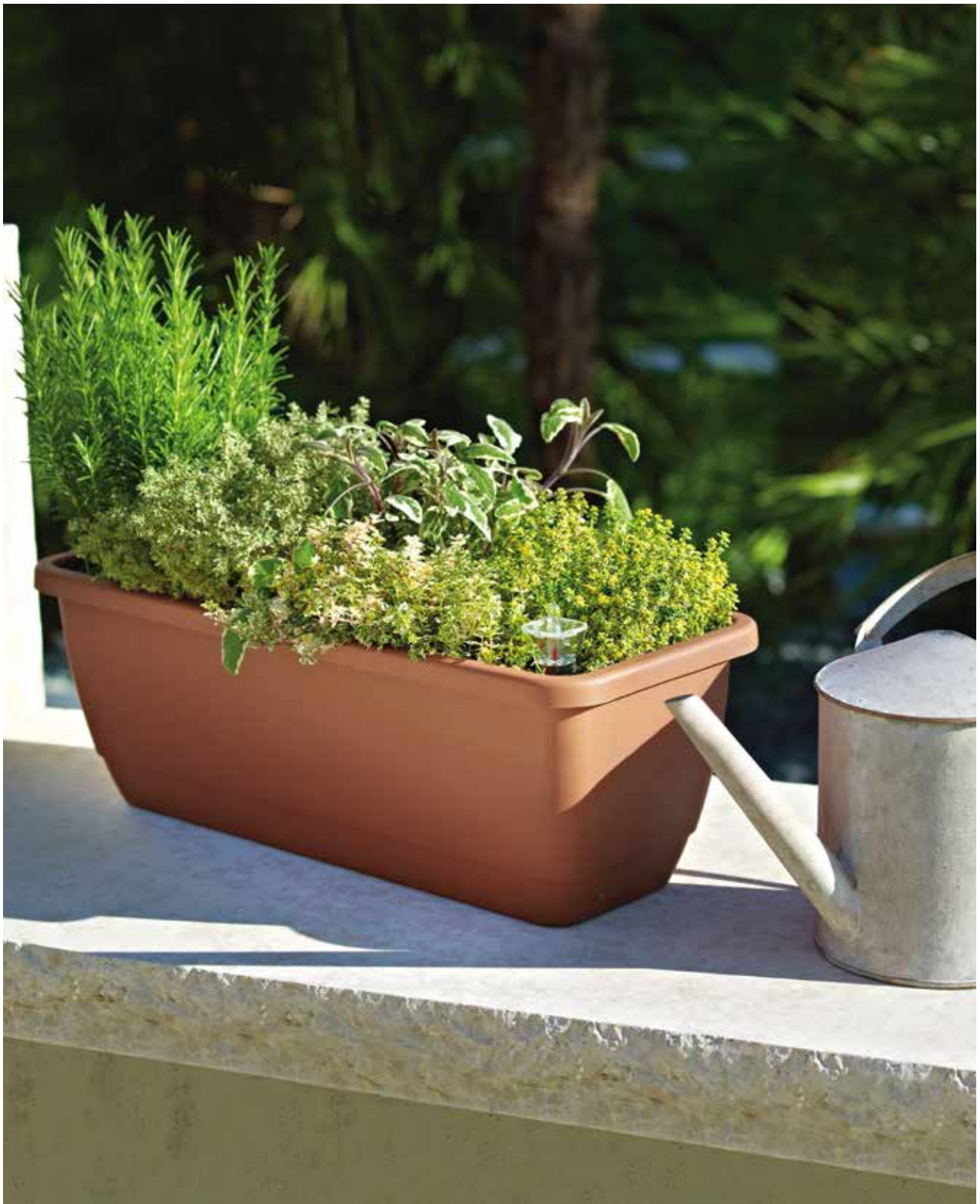

kalis • cassetta con riserva d'acqua • plant box with water reserve • pflanzkasten mit langzeitbewässerung
 jardinera con reserva de agua • jardinière avec réserve d'eau

art. 1943	cm. 50	(cm. 50 x 25 x 21 h.)	terra cap. lt. 14	acqua cap. lt. 2
art. 1894	cm. 60	(cm. 60 x 25 x 21 h.)	terra cap. lt. 17,4	acqua cap. lt. 2,6
art. 1895	cm. 80	(cm. 80 x 25 x 21 h.)	terra cap. lt. 24,8	acqua cap. lt. 3,2
art. 1896	cm. 100	(cm. 100 x 25 x 21 h.)	terra cap. lt. 30,8	acqua cap. lt. 4,2

espositori
displays
display-ständer
expositores
présentoirs

iko vasi
iko sottovasi
tree
tower air



iko vasi (cilindro • geo)

espositore con ruote frenanti per vasi • display with wheels and brakes for pots

display ständer mit feststellbaren rollen speziell für pflanzkübel • expositor de macetas con freno incorporado

présentoir avec roues autobloquantes pour pots

art. 2371 (cm. 110 x 110 x 236 h.)

quantità per diametro • quantity for each diameter • menge für diameter • cantidad por medida • quantité par diamètre:

Ø 20 (pcs.40)

Ø 25 (pcs.40)

Ø 30 (pcs.40)

Ø 35 (pcs.40)

Ø 40 (pcs.40)



iko sottovasi (medea)

espositore con ruote frenanti per sottovasi • display with wheels and brakes for saucers
 display-ständer mit feststellbaren rollen speziell für untersetzer • expositor de platos con freno incorporado
 présentoir avec roues autobloquantes pour soucoupes

art. 2652 (cm. 100 x 100 x 192 h.)

quantità per diametro • quantity for each diameter • menge für diameter • cantidad por medida • quantité par diamètre:

Ø 20 (pcs.100) Ø 24 (pcs.100) Ø 28 (pcs.100) Ø 32 (pcs.100) Ø 40 (pcs.100)



iko vasi (cilindro • geo)

espositore con ruote frenanti per vasi • display with wheels and brakes for pots

display ständer mit feststellbaren rollen speziell für pflanzkübel • expositor de macetas con freno incorporado

présentoir avec roues autobloquantes pour pots

art. 2371 (cm. 110 x 110 x 236 h.)

quantità per diametro • quantity for each diameter • menge für diameter • cantidad por medida • quantité par diamètre:

Ø 20 (pcs.40)

Ø 25 (pcs.40)

Ø 30 (pcs.40)

Ø 35 (pcs.40)

Ø 40 (pcs.40)



iko sottovasi (medea)

espositore con ruote frenanti per sottovasi • display with wheels and brakes for saucers

display-ständer mit feststellbaren rollen speziell für untersetzer • expositor de platos con freno incorporado

présentoir avec roues autobloquantes pour soucoupes

art. 2652 (cm. 100 x 100 x 192 h.)

quantità per diametro • quantity for each diameter • menge für diameter • cantidad por medida • quantité par diamètre:

Ø 20 (pcs.100)

Ø 24 (pcs.100)

Ø 28 (pcs.100)

Ø 32 (pcs.100)

Ø 40 (pcs.100)



tree (medea)

espositore con ruote frenanti per sottovasi • display with wheels and brakes for saucers
 display-ständer mit feststellbaren rollen speziell für untersetzer • expositor de platos con freno incorporado
 présentoir avec roues autobloquantes pour soucoupes

art. 2154 (cm. 100 x 100 x 212 h.)

quantità per diametro • quantity for each diameter • menge für diameter • cantidad por medida • quantité par diamètre:

Ø 10 (pcs.50)	Ø 14 (pcs.50)	Ø 18 (pcs.50)	Ø 22 (pcs.50)	Ø 26 (pcs.50)	Ø 30 (pcs.50)	Ø 36 (pcs.50)
Ø 12 (pcs.50)	Ø 16 (pcs.50)	Ø 20 (pcs.50)	Ø 24 (pcs.50)	Ø 28 (pcs.50)	Ø 32 (pcs.50)	Ø 40 (pcs.50)



tower air (air • dekus air)

espositore con ruote frenanti per sottovasi • display with wheels and brakes for saucer
 display-ständer mit feststellbaren rollen speziell für untersetzer • expositor de platos con freno incorporado
 présentoir avec roues autobloquantes pour soucoupes

art. 2758 (cm. 105 x 105 x 204 h.)

quantità per diametro • quantity for each diameter • menge für diameter • cantidad por medida • quantité par diamètre:

air:

Ø 10 (pcs.25)	Ø 18 (pcs.25)	Ø 26 (pcs.25)	Ø 40 (pcs.25)
Ø 12 (pcs.25)	Ø 20 (pcs.25)	Ø 28 (pcs.25)	
Ø 14 (pcs.25)	Ø 22 (pcs.25)	Ø 30 (pcs.25)	
Ø 16 (pcs.25)	Ø 24 (pcs.25)	Ø 35 (pcs.25)	

dekus air:

cm. 14 (pcs.20)	cm. 27 (pcs.20)
cm. 19 (pcs.20)	cm. 32 (pcs.20)
cm. 23 (pcs.20)	cm. 39 (pcs.20)

merchandising tools

coverpallet

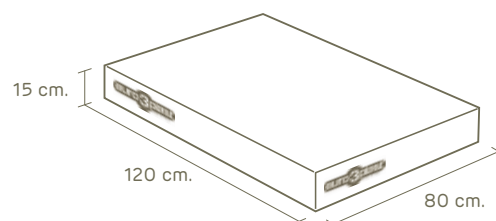

vaso GEO + sottovaso MEDEA





vaso GEO + sottovaso MEDEA

- 03
- 62
- 86
- 18
- 44

cassetta + sottocassetta INIS

- 03
- G9
- 62
- 86
- 18
- 44



vaso + sottovaso KREA





cassetta + sottocassetta AKEA

- 03
- 69
- 62
- 01



ciotola OLIMPO + sottovaso MEDEA

03

69

86

44



ciotola OLIMPO + sottovaso MEDEA

- M9
- N1
- L4

merchandising tools

pallet box

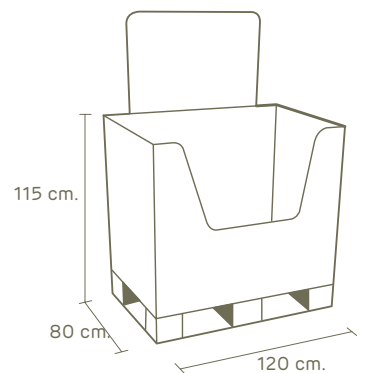

vaso GEO + sottovaso MEDEA



vaso GEO + sottovaso MEDEA

- 03
- 62
- 86
- 18
- 44

cassetta + sottocassetta INIS

- 03
- 69
- 62
- 86
- 18
- 44



cassetta + sottocassetta INIS + portacassetta



Scegliete una pianta e un vaso Lhicum collection
per decorare i vostri ambienti!

Choose a plant and a Lhicum collection pot to decorate
your indoor and outdoor living space!

Verschönern Sie ihr Zuhause innen und außen
mit einem Topf der Lhicum collection!

¡Elijan una planta y una maceta Lhicum collection
para decorar sus ambientes!

Choisissez une plante et un pot Lhicum collection
pour décorer votre environnement!



miza 50 + rosmarinus officinalis, thymus vulgaris, mentha, salvia officinalis

geo 25 + scindapsus



inis 50 + chlorophytum



geo 25 + philodendron



krea 40 + dracaena







indice generale

general index • inhaltsverzeichnis

indice general • index general

art.	pag.
cassette • plant box • pflanzkästen • jardineras • jardinières:	
akea	p. 26
gerani	p. 62
inis	p. 16
kalis	p. 12
miza	p. 10
rigata	p. 24
cassette con riserva d'acqua • plant boxes with water reserve • pflanzkästen mit langzeitbewässerung jardineras con reserva de agua • jardinières avec reserve d'eau:	
kalis	p. 69
cassette con sottocassetta • plant boxes with oblong tray • pflanzkästen mit untersetzer jardineras con bandeja • jardinières avec plateau:	
dune	p. 22
gerus	p. 14
licum	p. 20
ciotole • plant bowls • pflanzschalen • terrinas • coupes:	
azem appesa con sottovaso montato	p. 51
eolia appesa con sottovaso montato	p. 50
eolia con sottovaso montato	p. 47
olimpo	p. 48
espositori • displays • display • ständer • expositores • présentoirs:	
iko vasi	p. 72-74
iko sottovasi	p. 73-75
tower air	p. 77
tree	p. 76
fioriere • vases • blumenspindeln • copas • coupes sur pied:	
azem	p. 54
gerle con sottovaso • wall pots with saucer • wandkübel mit untersetzer macetas de pared con plato • pots mural avec soucoupe:	
domus	p. 53
olimpo	p. 52

art.

pag.

sottocassette • oblong trays • untersetzer • bandejas • plateaux:

akea	p.	26
garden	p.	62
gerani	p.	62
inis	p.	16
kalis	p.	12
maxi	p.	63
mini	p.	63
miza	p.	10
moplen	p.	66

sottovasi • saucers • untersetzer • platos • soucoupes:

air	p.	59
dekus air	p.	58
krea angolo	p.	34
krea a muro	p.	32
krea quadro	p.	28
medea	p.	56
moplen	p.	66
quadro	p.	63
sabbiato	p.	63
sottovaso con ruote montate	p.	60

vasi • pots • pflanzkübel • macetas • pots:

cilindro	p.	44
coccio	p.	37
dune	p.	36
garden	p.	64
geo	p.	40
konis con sottovaso	p.	46
krea angolo	p.	34
krea a muro	p.	32
krea quadro	p.	28
linto	p.	38

& co.

pedino	p.	45
--------	----	----

indice articoli per nome

items index listed by name • alphabetisches artikelverzeichnis
indice de articulos por nombre • index des produits par ordre nominal

art.	pag.
a:	
air (sottovaso trasparente • transparent saucer)	p. 59
akea (cassetta • plant box)	p. 26
akea (sottocassetta • oblong tray)	p. 26
azem (ciotola appesa con sottovaso montato • hanging plant bowl with attached saucer)	p. 51
azem (fioriera • vase)	p. 54
c:	
cilindro (vaso • pot)	p. 44
coccio (vaso • pot)	p. 37
d:	
dekus air (sottovaso quadro trasparente • transparent square saucer)	p. 58
domus (gerla • wall pot)	p. 53
dune (cassetta con sottocassetta • plant box with oblong tray)	p. 22
dune (vaso • pot)	p. 36
e:	
eoliā (ciotola con sottovaso montato • plant bowl with saucer with attached saucer)	p. 47
eoliā (ciotola appesa con sottovaso montato • hanging plant bowl with attached saucer)	p. 50
g:	
garden (sottocassetta • oblong tray)	p. 62
garden (vaso • pot)	p. 64
geo (vaso • pot)	p. 40
gerani (cassetta • plant box)	p. 62
gerani (sottocassetta • oblong tray)	p. 62
gerus (cassetta con sottocassetta • plant box with oblong tray)	p. 14
i:	
iko vasi (espositore con ruote per vasi • pot display on wheels)	p. 72-74
iko sottovasi (espositore con ruote per sottovasi • saucer display on wheels)	p. 73-75
inis (cassetta • plant box)	p. 16
inis (sottocassetta • oblong tray)	p. 16
k:	
kālis (cassetta • plant box)	p. 12
kālis (cassetta con riserva d'acqua • plant box with water reserve)	p. 69
kālis (sottocassetta • oblong tray)	p. 12
konis (vaso con sottovaso • pot with saucer)	p. 46
krea (sottovaso a muro • wall saucer)	p. 32
krea (sottovaso angolo • angle saucer)	p. 34
krea (sottovaso quadro • square saucer)	p. 28
krea (vaso a muro • wall pot)	p. 32
krea (vaso angolo • angle pot)	p. 34
krea (vaso quadro • square pot)	p. 28

art.	pag.
l:	
licum (cassetta con sottocassetta • plant box with oblong tray)	p. 20
linto (vaso • pot)	p. 38
m:	
maxi (sottocassetta • oblong tray)	p. 63
medea (sottovaso • saucer)	p. 56
mini (sottocassetta • oblong tray)	p. 63
miza (cassetta • plant box)	p. 10
miza (sottocassetta • oblong tray)	p. 10
moplen (sottocassetta • oblong tray)	p. 66
moplen (sottovaso • saucer)	p. 66
o:	
olimpò (ciotola • plant bowl)	p. 48
olimpò (gerla con sottovaso • wall pot with saucer)	p. 52
p:	
pedino (pedino • little base)	p. 45
q:	
quadro (sottovaso • saucer)	p. 63
r:	
rigata (cassetta • plant box)	p. 24
s:	
sabbiato (sottovaso • saucer)	p. 63
sottovaso con ruote montate (sottovaso con ruote • saucer with rollers)	p. 60
t:	
tower air (espositore con ruote per sottovasi • saucer display on wheels)	p. 77
tree (espositore con ruote per sottovasi • saucer display on wheels)	p. 76

indice colori

colors index • farbverzeichnis
 indice de colores • index des couleurs

E1 neutro trasparente transparent transparent transparente transparent	color 2015 N1 giada jade jade jade jade	01 terracotta terracotta terracotta terracota terre cuite
98 neutro neutral neutral transparente neutre	86 verde acido acid green apfel grün verde acido vert pastel	71 arancio orange orange naranja orange
03 bianco white weiss blanco blanc	02 verde green grün verde vert	45 terra di siena
M9 sabbia sandy sand arena sable	color 2015 L4 rosmarino rosemary rosmarin romero romarin	59 beige puntinato light sandstone beige marmoriert beige granite beige granite
G9 tortora taupe taupe tortola tourterelle	18 ottanio petrol blue petrol azul ottanio bleu ottanio	
62 antracite anthracite grey anthrazit antracita anthracite	44 ciclamino cyclamen cyclamrot cyclamen cyclamen	

ATTENZIONE: La stampa su carta non sempre riproduce fedelmente i colori dei prodotti.

Le immagini e i dati riportati in questo catalogo sono indicativi. **Euro3plast spa** si riserva il diritto di apportare eventuali variazioni o migliorie agli articoli illustrati, anche senza preavviso. I nostri uffici commerciali rimangono a vostra completa disposizione per qualsiasi ulteriore delucidazione.

Tutto il materiale contenuto in questo catalogo, compresi i testi, le fotografie, i disegni, è proprietà di **euro3plast spa** e pertanto è protetto dalle leggi che tutelano la proprietà intellettuale. Per tale motivo non può essere utilizzato senza esplicita autorizzazione scritta da **euro3plast spa**.

ATTENTION: The print on the paper doesn't grant the accurate reproduction of the colors.

The images and the indicated data in our catalogue are approximate. **Euro3plast spa** reserves the right to effect any changes or improvements, to the illustrated articles, also without notice. For further information, our Customer Service are at your disposal.

All the material in this catalogue (including texts, photos and drawing), belong to **euro3plast spa**. Therefore it is protected by laws defending intellectual property. For this reason it cannot be used by anybody without the prior and written authorization of **euro3plast spa**.

SISTEMA DI GESTIONE INTEGRATO INTEGRATED MANAGEMENT SYSTEM



SISTEMA DI GESTIONE QUALITÀ (UNI EN ISO 9001:2008)

Introdotta nel 1997 per affermare la serietà commerciale dei nostri prodotti ed esaudire le esigenze dei nostri clienti, segue la Norma UNI EN ISO 9001:08 ed è certificata dall'Ente Det Norske Veritas Italia s.r.l.

QUALITY MANAGEMENT SYSTEM (UNI EN ISO 9001:2008)

Introduced in 1997 to confirm the commercial soundness of our products and to meet our customers' requirements, our Quality Management System complies with the UNI EN ISO 9001:08 Standard and is certified by Det Norske Veritas Italia s.r.l.



SISTEMA DI GESTIONE AMBIENTALE (UNI EN ISO 14001:2004)

Siamo da sempre sensibili alle tematiche ambientali: nel 2001, a conferma del nostro impegno, abbiamo adottato anche un Sistema di Gestione Ambientale certificato dell'Ente Det Norske Veritas Italia s.r.l secondo quanto previsto dalla Norma UNI EN ISO 14001:04.

ENVIRONMENT MANAGEMENT SYSTEM (UNI EN ISO 14001:2004)

We have always been sensitive to environment issues: in 2001, in order to confirm our commitment, we also adopted an Environment Management System certified by Det Norske Veritas Italia s.r.l. in accordance with the provisions of the UNI EN ISO 14001:04 Standard.



SISTEMA DI GESTIONE DELLA SICUREZZA (OHSAS 18001:2007)

Il nostro impegno per la sicurezza sui luoghi di lavoro è continuo, da sempre. E come testimonianza della nostra attenzione abbiamo ottenuto, nel 2013, la certificazione del Sistema di Gestione della Sicurezza OHSAS 18001:2007, la norma, che sancisce la propensione al miglioramento continuo nelle attività svolte dai lavoratori che operano per la nostra organizzazione, nel rispetto della legislazione vigente e dei più avanzati standard nazionali ed internazionali.

SAFETY MANAGEMENT SYSTEM (OHSAS 18001:2007)

We have always been consistent in our commitment to safety at the workplace. And as testament to our attention, we have achieved, in 2013, certification of our Safety Management System OHSAS 18001:2007, a standard which approves our propensity to ongoing improvement in the tasks our personnel perform, in keeping with current laws and the most advanced national - and international standards.



